

YTONG KÉSZ HÁZ PROGRAM

105 Ytong Lambda Típusterv

Xella



YTONG



Földszintes családi ház

Alapterület: 112,30 m²

Lakóterület: 77,30 m²

U=0,19 W/m²K

Falszerkezet: Ytong Lambda 45

Födémszerkezet: Ytong DE



BERENDEZÉSI ALAPRAJZ

Ios

Xella





Ios

Dél-nyugati homlokzat ↗

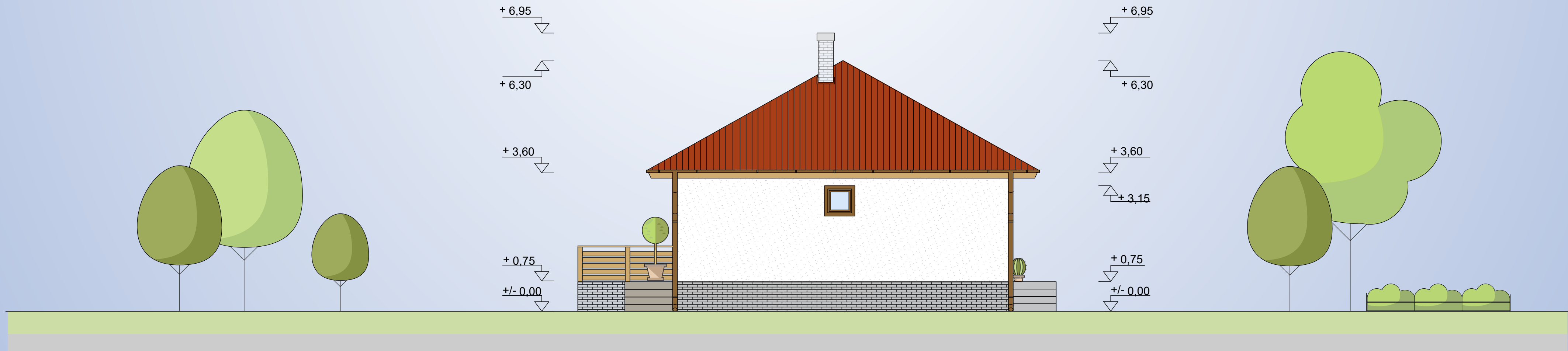

Észak-keleti homlokzat ↖

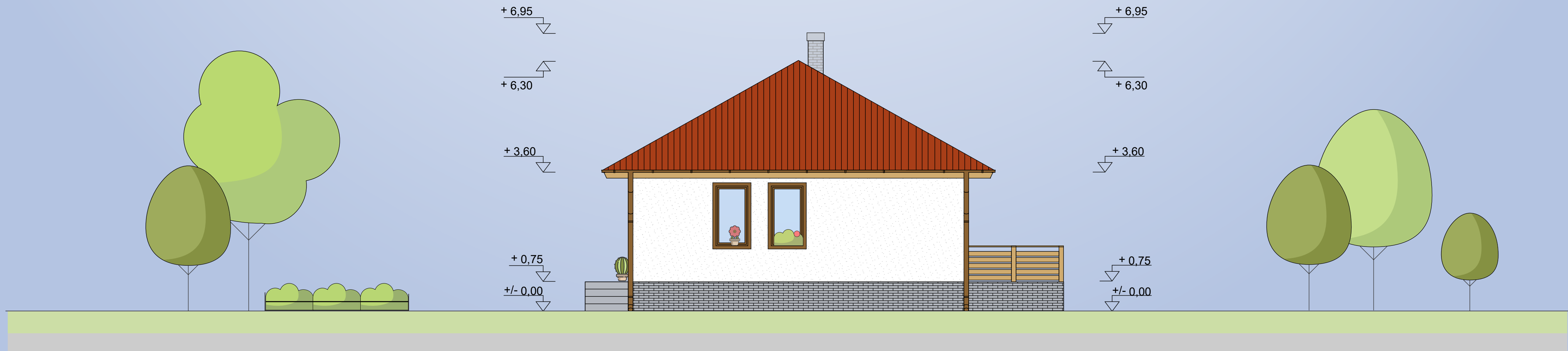

Ios

Dél-keleti homlokzat

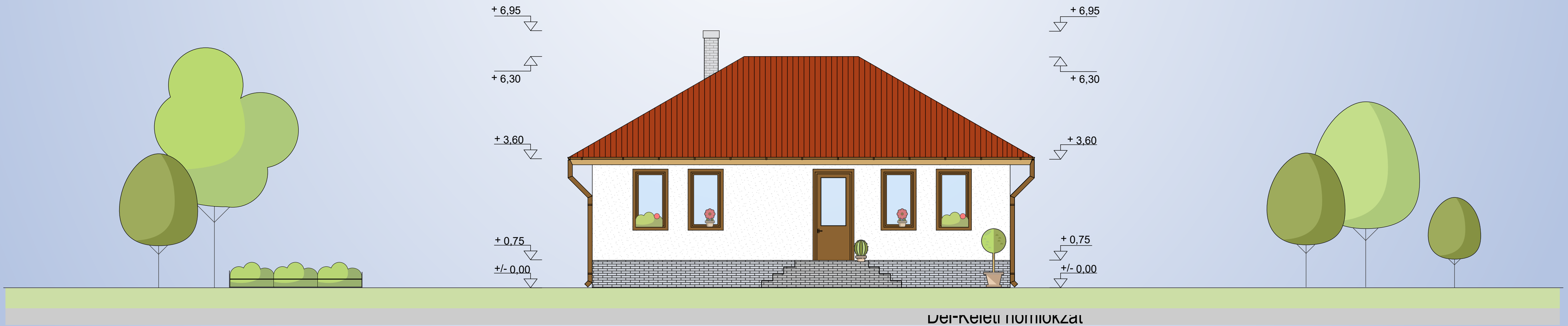

Észak-nyugati homlokzat

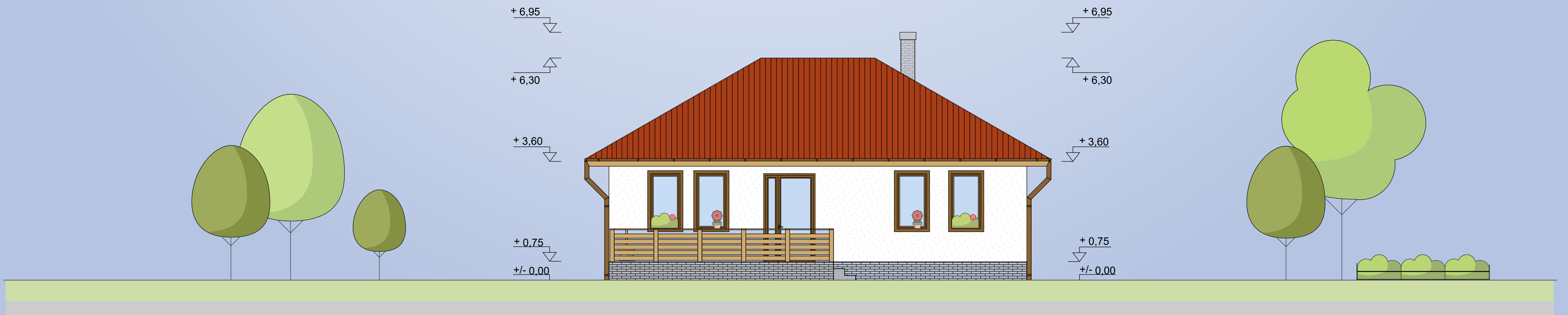

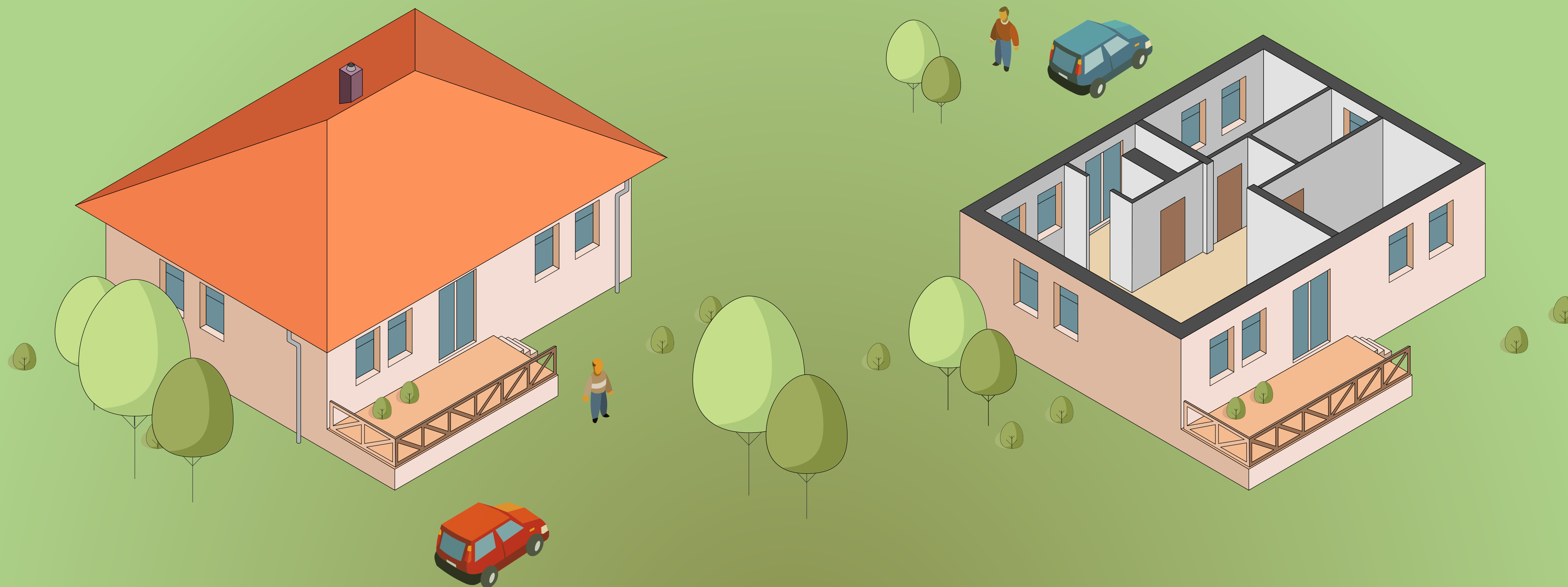

Ios

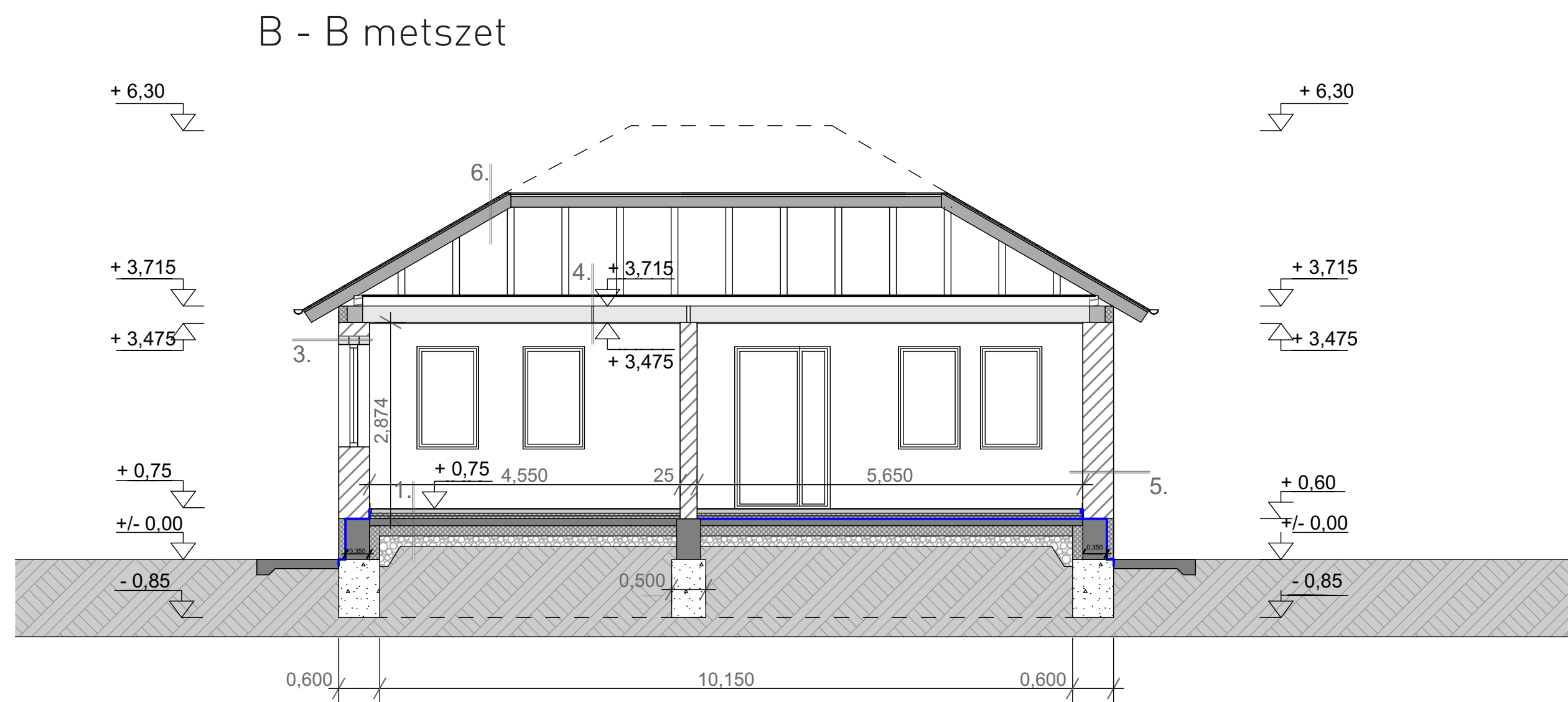
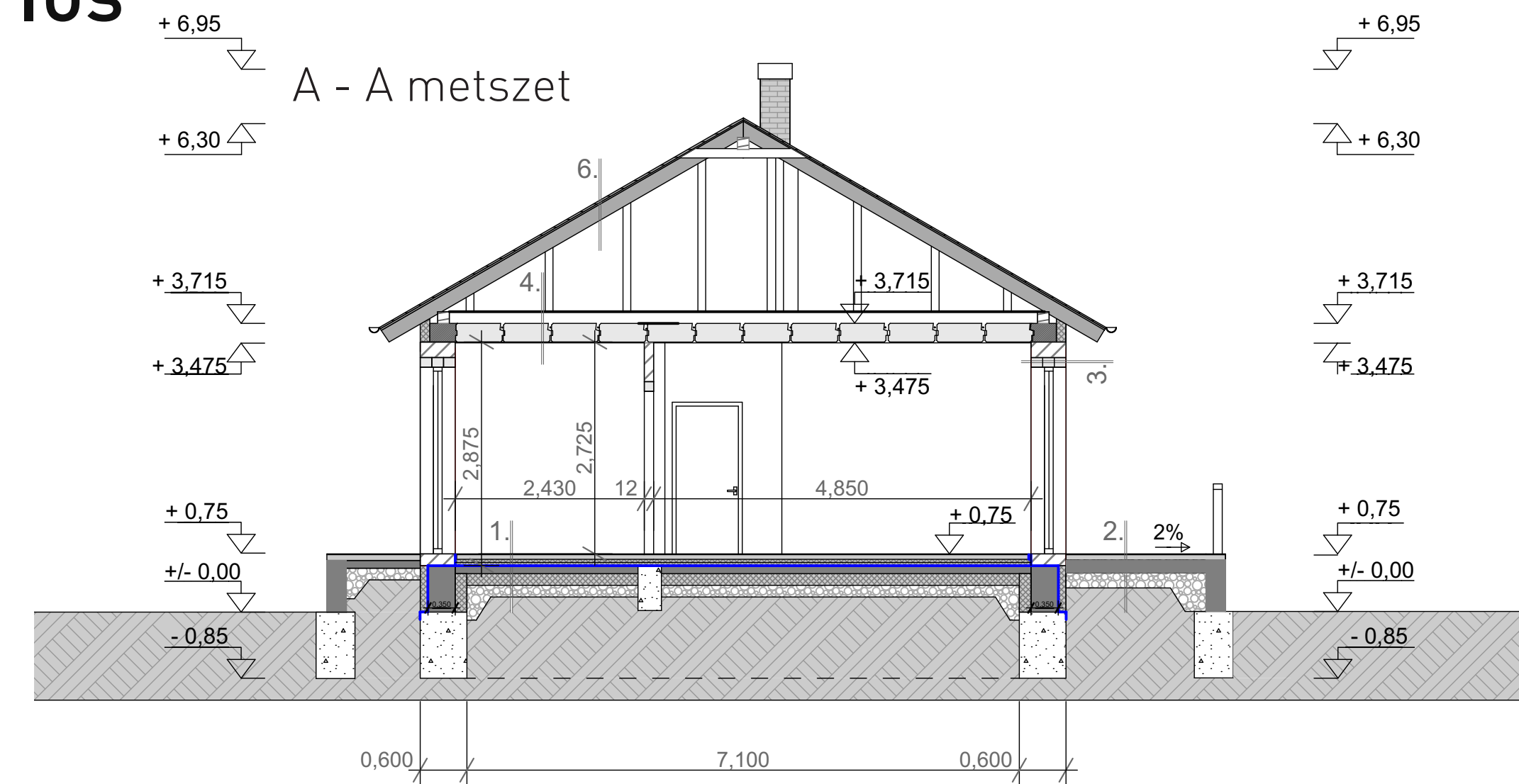

1.

1. padlóburkolat 1 cm
2. aljzatkiegyenlítés 1 rtg.
3. aljzatbeton 6 cm
4. elválasztó tech.szig.1 rtg.
5. lépésálló hőszigetelés 8 cm
6. elválasztó tech.szig.1 rtg.
7. vízszigetelés
8. kellősítés
9. vasalt aljzat 10 cm
10. elválasztó réteg
11. hőszigetelés
12. kavics feltöltés 15 cm

2.

1. kültéri padlóburkolat 2 cm
2. aljzatbeton 6 cm
3. vasalt aljzat 15 cm
4. kavics feltöltés 15 cm
5. talajfeltöltés 15 cm

3.

1. nemesvakolat
2. Ytong PSF/150 áthidaló
3. beltéri vékony vakolat
4. glett
5. beltéri falfesték

4.

1. Ytong DE földémpalló 24 cm
2. beltéri vékony vakolat
3. glett
4. beltéri festék

5.

1. nemesvakolat
2. Ytong Lambda 45 cm
3. beltéri vékony vakolat
4. glett
5. beltéri falfesték

6.

1. kerámia tetőcserép
2. tetőléc
3. szarufa 10/15

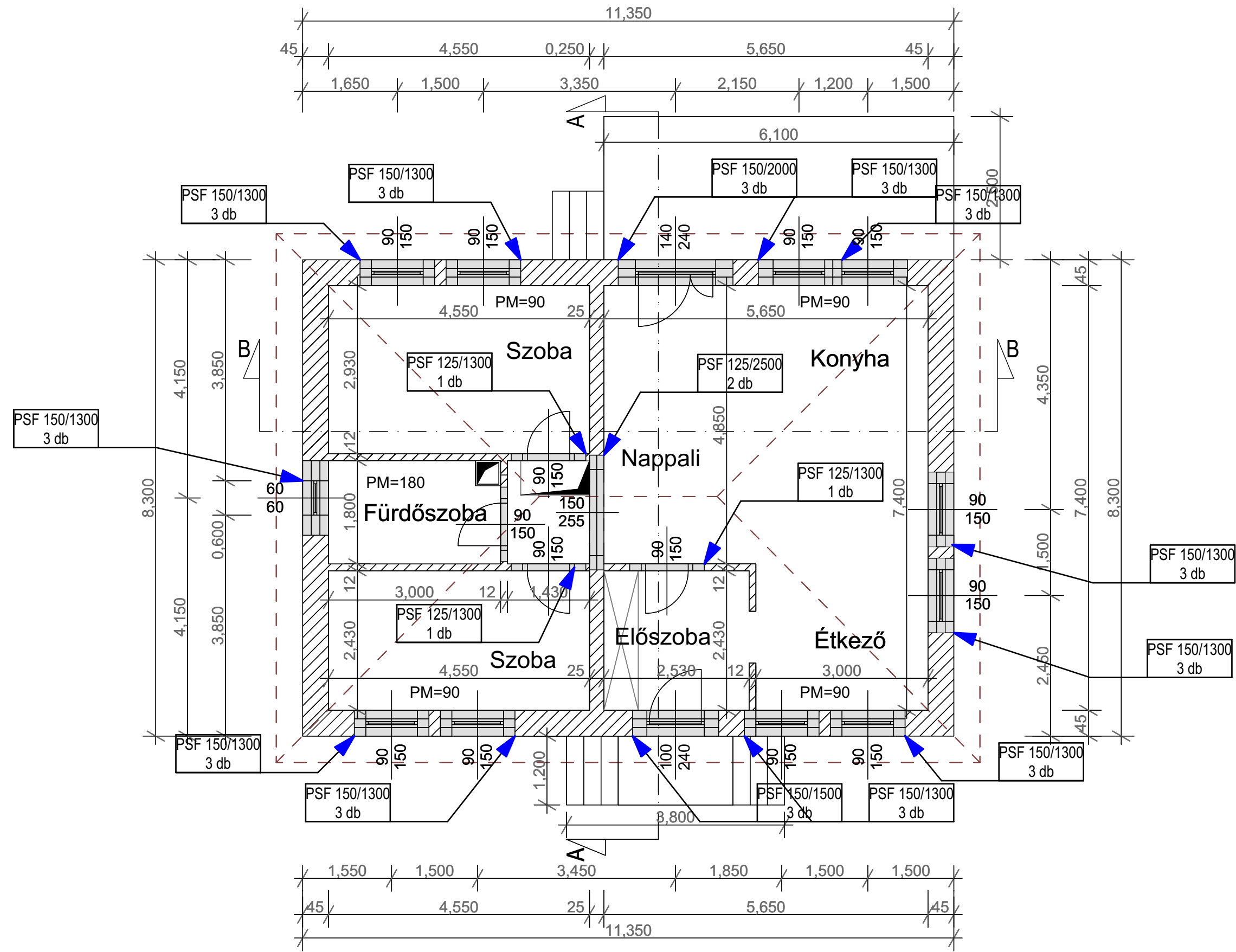
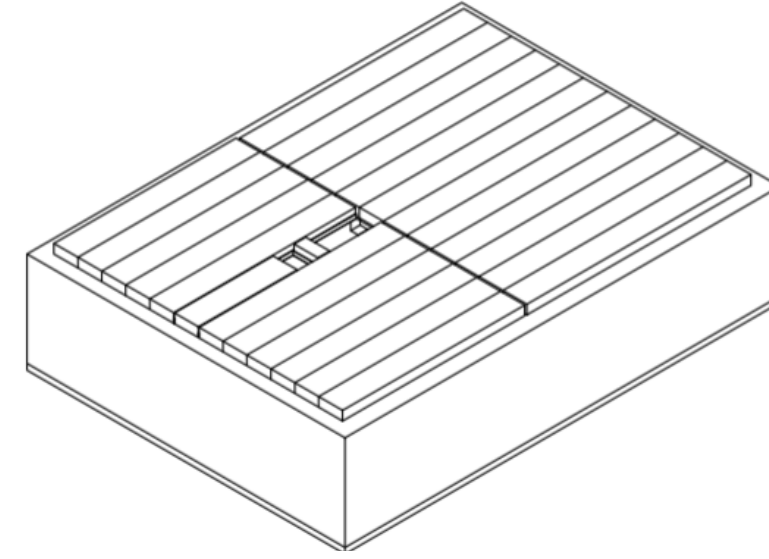

Áthidaló kiosztási terv

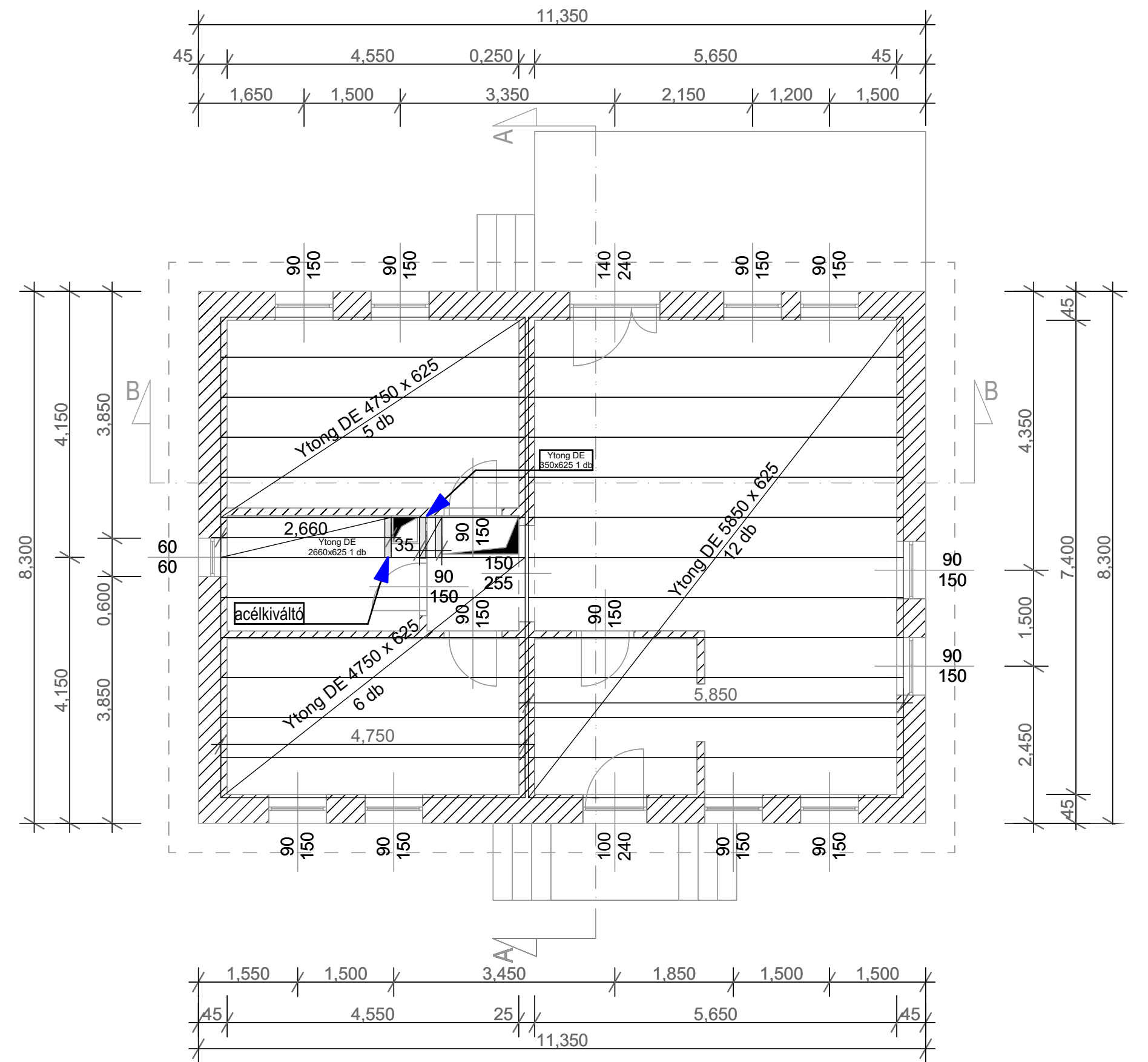

Födémterv